

NISSAN INTELLIGENT MOBILITY™

Nissan Intelligent Mobility guides everything we do. We're using new technologies to transform cars from mere driving machines into partners. Together the journey is more confident, connected, and exciting. Whether it's cars that share the task of driving with you, or highways that charge your EV as you go along, it's all in the very near future. And it's a future already taking shape in the Nissan you drive today.

NISSAN FRONTIER®

Isn't it time you were passionate about the truck you drive? Welcome to the 2019 Frontier.

Follow Nissan Canada on:



Innovation
that excites

2019
FRONTIER®



Innovation
that excites

visit nissan.ca

Facebook® is a registered trademark of Facebook, Inc. Twitter® is a registered trademark of Twitter, Inc. YouTube® is a registered trademark of Google LLC. Instagram® is a registered trademark of Instagram, LLC.

All illustrations, photographs and specifications in this brochure are based on the latest product information. See actual vehicle for complete accuracy. Nissan Canada Inc. reserves the right to make changes at any time, without notice, in prices, colours, materials, equipment, specifications and models, and to discontinue models or equipment. For information on additional options and accessories, contact your Nissan Dealership. Registered trademarks are property of their respective owners.

At nissan.ca, you'll find a way to "build your own Nissan," a dealer locator, and more information about key Nissan support services. The Nissan names, logos, product names, feature names, and slogans are trademarks owned by or licenced to Nissan Motor Co. Ltd. and/or its North American subsidiaries. **Always wear your seat belt, and please drive responsibly.** Printed in November 2018. Catalogue number: 99999-FRO19EN. ©2018 Nissan Canada Inc. All rights reserved.



Take the path less travelled. On-road or off. Power through most every job, big or small. Stop. Back it up. Take a look at what's directly behind you, hitch up your weekend toys, and go.¹ With the Nissan Navigation System^{2,3} and off-road technologies,³ the world is your playground. The 2019 Nissan Frontier.[®]

Nissan Frontier[®] Midnight Edition Crew Cab[®] shown in Magnetic Black.

¹Towing capability varies by configuration. See Nissan Towing Guide and Owner's Manual for additional information. ²Never program while driving. GPS mapping may not be detailed in all areas or reflect current road status. ³Available feature.

V6

ENGINE

261

HORSEPOWER

281

LB.-FT. OF TORQUE

UP TO 6,710

LBS (3,044 KG) MAX TOWING¹



PRO-4X[®]

PRO-4X — THE ULTIMATE OFF-ROAD FRONTIER
Exhibit championship form with Bilstein[®] off-road performance shocks, an electronic locking rear differential, 4-wheel Active Brake Limited Slip (ABLS), skid plates, and all-terrain tires. And with 16" 6-spoke alloy wheels, unique bedside decals, and an exclusive interior with white-faced gauges — PRO-4X looks the part.



U.S. instrumentation shown.

HILL START ASSIST When starting up steep hills, hill start assist helps keep you from rolling backwards. It briefly holds brake pressure so you can switch from the brake pedal to the accelerator.³

HILL DESCENT CONTROL When driving down a steep grade in 4WD, hill descent control automatically maintains speed and brake pressure to help provide a controlled descent.³

ELECTRONIC LOCKING REAR DIFFERENTIAL Adding to the capability of the 4x4, the available electronic-locking rear differential delivers equal power to both rear wheels, boosting traction to help keep you moving forward.

PICK YOUR POWER

V6 ENGINE With an available 4.0-litre V6 engine packing 261 horsepower, your Frontier[®] is chomping at the bit. And with a massive 281 lb.-ft. of torque, you can tow or haul just about anything you need to bring along.¹

A 4-CYLINDER THAT FEELS LIKE A 6 Frontier also offers a 2.5-L 4-cylinder that pumps out 152 horsepower and 171 lb.-ft. of torque, and features a compact balancer system to deliver the smoothness of a V6.

GEAR UP You can harness the 4-cylinder's power through a standard 5-speed automatic transmission. The V6 is available with either a 6-speed manual² or 5-speed automatic transmission.

¹Maximum towing capacity when properly equipped. Maximum towing of 6,710 lbs. (3,044 kg) for Frontier SV King Cab[®] 4x2. Towing capability varies by configuration. See Nissan Towing Guide and Owner's Manual for additional information. ²PRO-4X[®] King Cab[®] models only. ³Automatic transmissions only. Cargo shown for display purposes only. Cargo and load capacity limited by weight and distribution. Always secure all cargo. Heavy loading of the vehicle with cargo, especially on the roof, will affect the handling and stability of the vehicle. Bilstein[®] is a registered trademark of ThyssenKrupp Bilstein GmbH.

Nissan Frontier[®] SV King Cab[®] 4x2 shown in Brilliant Silver with optional equipment.



Nissan Frontier[®] PRO-4X[®] King Cab[®] shown in Cayenne Red.

FOUR WALLS ARE STRONGER THAN THREE

That's why Frontier® features a full-length, fully boxed ladder frame – instead of the three-sided, open C-shape rails found on some other trucks. The frame is built with super-high-tensile-strength steel in strategic areas for enhanced structural rigidity and improved performance, on- and off-road.

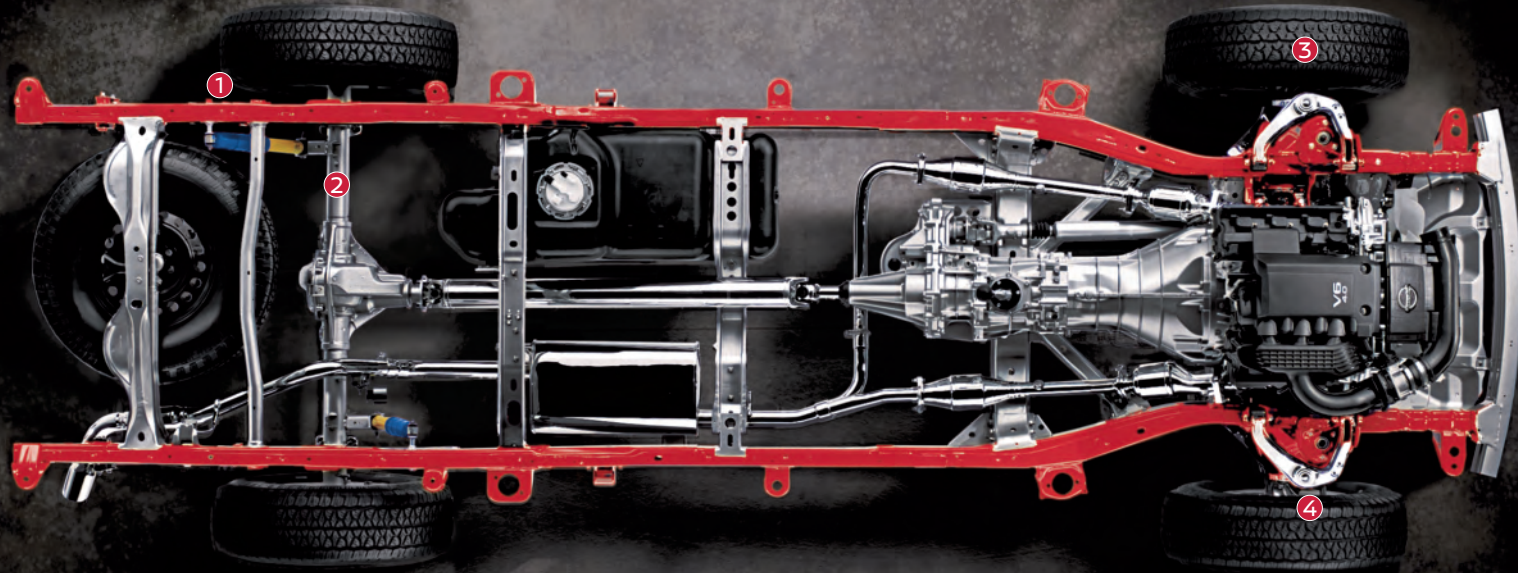
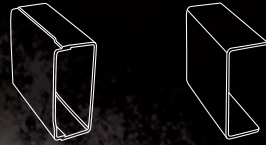

- ① Overslung rigid leaf-spring rear suspension
- ② Available heavy-duty rear axle
- ③ 4-wheel vented disc brakes with Anti-lock Braking System (ABS)
- ④ Steel double-wishbone front suspension

Anti-lock Braking System (ABS) helps you maintain steering control around obstacles while braking heavily.

Electronic Brake force Distribution (EBD) sends extra force to the rear brakes when you have the additional weight of passengers or cargo in the back.

Vehicle Dynamic Control (VDC)¹ helps you maintain your steered path.

Active Brake Limited Slip (ABLS) senses when a wheel begins to slip, then automatically brakes the slipping wheel and sends additional power to the wheel (or wheels) with the best traction.

NISSAN UTILI-TRACK® SYSTEM

CARGO ON LOCKDOWN

Five channels, four cleats, and a lot of thought about how people really use their trucks. This makes a system that's simple, rugged, and offers near-infinite possibilities when it comes to securing cargo.

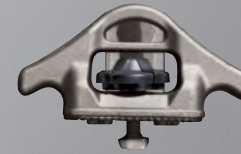

4 CLEATS

Four heavy-duty forged aluminum cleats easily slide in the channels for the flexibility to tie things down – and the strength to hold them.

5 CHANNELS

Unmatched versatility comes in the form of five channels – including two channels in the floor. And since you can lock the cleat anywhere along the rail, Frontier makes sure you find the best position to secure whatever you bring along.



SPRAY-ON BEDLINER

Adding to the incredible versatility of the bed, the available spray-on bedliner is applied at the factory – so you know it's done right. Fade and weather resistant, it's a rugged, non-skid surface that adheres directly to the bed to help prevent rusting.



LOADS OF ACCESSORIES

There's also a full line of accessories to help you get even more out of Utili-track, including a Sliding Tool Box², a Sliding Bed Divider, and a Sliding Bed Extender.

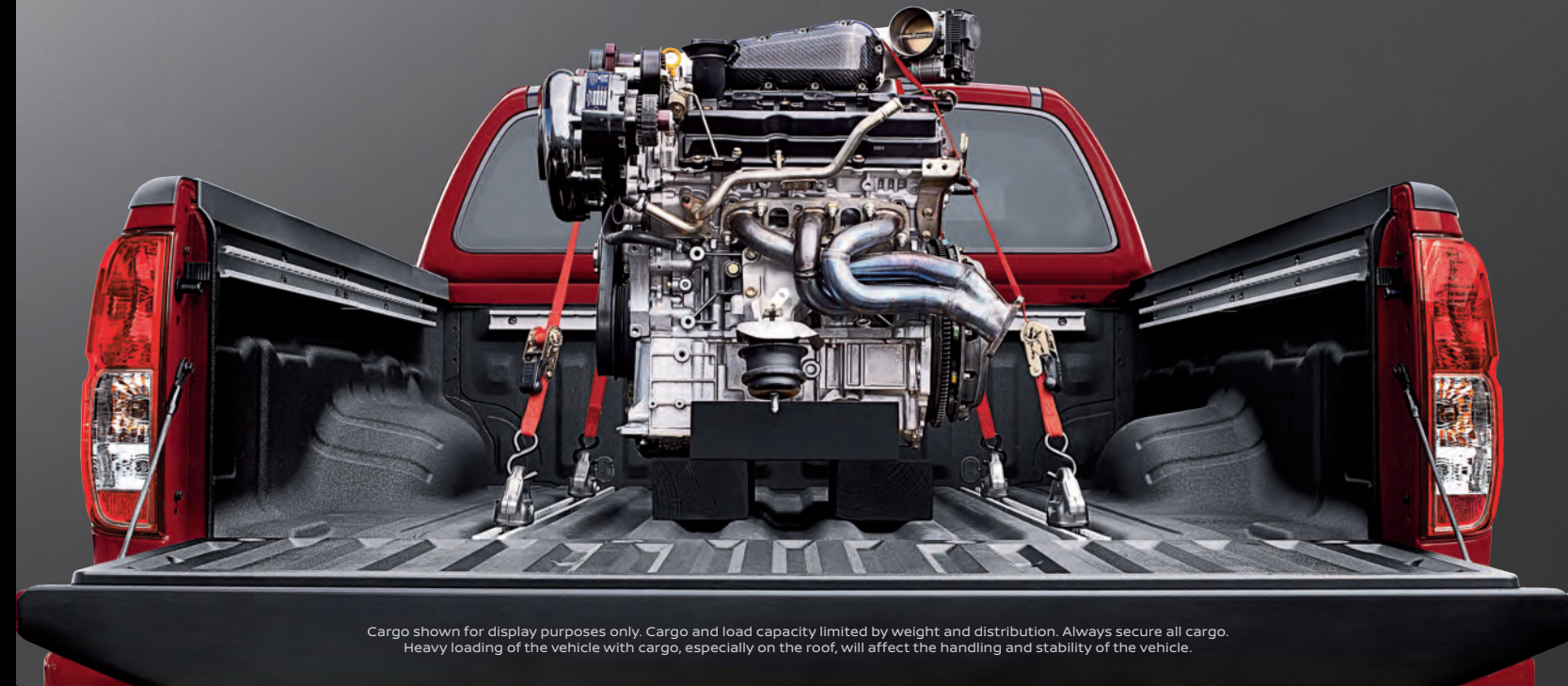

Cargo shown for display purposes only. Cargo and load capacity limited by weight and distribution. Always secure all cargo. Heavy loading of the vehicle with cargo, especially on the roof, will affect the handling and stability of the vehicle.

¹VDC, which should remain on when driving except when freeing the vehicle from mud or snow, cannot prevent accidents due to abrupt steering, carelessness, or dangerous driving techniques. ²Tool Box Tray shown in photo is sold separately. See your Nissan dealer for more information. Some components have been chrome-plated or painted for display purposes only.

FRONTIER® CREW CAB

Space or comfort? Why not both? Forward-hinged doors make for easy entry, while an available 60/40 split rear bench allows seating for five and easily folds down to create more space. Or flip up the rear seat cushions for more storage room. There's also an under-seat storage tray that's removable for even greater flexibility.

FOLDS DOWN

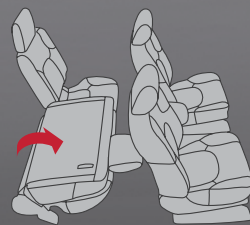

FLIPS UP

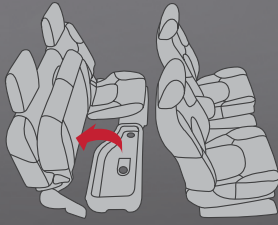

Nissan Frontier® SL Crew Cab shown in Steel Leather.

FRONTIER KING CAB®

Smart design means rear doors that give your passengers easy access to the cabin. And with no B-pillars, you also get a huge opening for oversized items. The two rear seats flip up and out of the way to reveal a wide open space for cargo.



Nissan Frontier® PRO-4X® King Cab® shown in Graphite Steel Cloth.

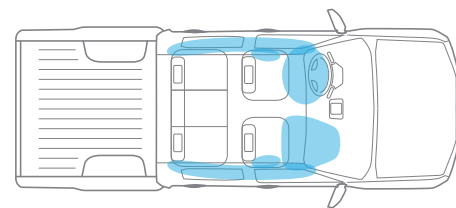

6 STANDARD AIRBAGS¹

Safety first and foremost In Frontier, making your protection our priority starts with six standard airbags, including seat-mounted side-impact supplemental airbags and roof-mounted curtain side-impact supplemental airbags. The advanced front seat belts on every Frontier feature pre-tensioners that automatically help tighten the belts when the front airbags deploy.¹ And if your body puts too much force on the belt, load limiters give a bit. During a rear-end impact, front-seat Active Head Restraints move up and toward you to meet your head part of the way, helping close the gap and reducing the chance of whiplash.

¹Airbags are only a supplemental restraint system; always wear your seat belt. Even with the occupant-classification sensor, rear-facing child restraints should not be placed in the front-passenger's seat. Also, in addition to any other requirement of applicable law, all children 12 and under should ride in the rear seat properly secured in child restraints, booster seats, or seat belts according to their size. And please see your King Cab® Owner's Manual for specific information about the safest way to secure a child restraint in a Frontier® King Cab®. Airbags will only inflate in certain accidents; see your Owner's Manual for more details. Inflated airbags shown for illustration purposes only, actual coverage area may differ. Airbags deflate after deployment.

NISSAN INTELLIGENT MOBILITY™

TAKE THINGS UP A NOTCH

Whether you're on the job or on the go, Frontier® meets your demands. Embrace a great-looking interior plus an available leather-wrapped steering wheel. Crank up the available Rockford Fosgate®-powered audio system.¹ Make and take calls with your hands on the wheel using the Bluetooth® Hands Free Phone System.^{2,3} And get things the way you like it with available Dual Zone Automatic Temperature Control.



The RearView Monitor automatically activates whenever you're in Reverse, making it ideal for lining up your approach to a trailer. Now that's handy.^{4,5}

NissanConnect®

YOUR WORLD AT YOUR FINGERTIPS

Nissan Intelligent Mobility brings you seamless connectivity. Available NissanConnect Mobile Apps makes your Frontier become your smartphone's best friend.^{2,3,6} Now your own hand-picked music, latest tweets, TripAdvisor® tips, Facebook® events, and more, are all working together with your compatible smartphone and Frontier's available colour touch-screen.^{2,3,6} Your Nissan Frontier also keeps you in the loop with the available Nissan Navigation System with Nissan Voice Recognition for navigation and audio,⁷ hands-free Text Messaging Assistant,⁸ Bluetooth® Hands Free Phone System calling and streaming audio,^{2,3} plus a USB port.⁹

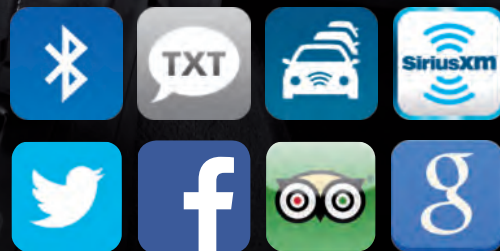

U.S. instrumentation shown. ¹PRO-4X® Crew Cab and SL Crew Cab models only. ²Availability of specific features is dependent upon the phone's Bluetooth® support. Please refer to your phone Owner's Manual for details. Bluetooth® word mark and logos are owned by Bluetooth SIG, Inc., and any use of such marks by Nissan is under licence. ³Available services/features may be shown. Compatible connected device may be required. Only use services/features and device when safe and legal to do so. Subject to GPS and wireless network availability and connection, and system/technology limitations. Text rates/data usage/subscription may apply. Some services/features provided by companies not within Nissan or its partners' or agents' control and may be discontinued at any time. For more information, see Dealer or Owner's Manual. ⁴Parking aid/convenience feature. Cannot completely eliminate blind spots. May not detect every object and does not warn of moving objects. Always check surroundings and turn to look behind you before moving vehicle. ⁵King Cab® 4x2 models with V6. 7-pin connector trailer wire harness and tow hitch receiver required. See Nissan Towing Guide and Owner's Manual for additional information. ⁶XM® and SiriusXM® Satellite Radio is available in the 10 Canadian provinces and the 48 contiguous United States. Subscription sold separately after trial period. All subscriptions subject to customer agreement at siriusxm.ca/terms. All fees and programming subject to change. ©2019 Sirius XM Canada Inc. The Sirius, XM, and SiriusXM names and all related marks and logos are trademarks of Sirius XM Radio Inc. All other trademarks are the property of their respective owners. ⁷Never program while driving. GPS mapping may not be detailed in all areas or reflect current road status. ⁸Use the Text Messaging feature after stopping your vehicle in a safe location. If you have to use the feature while driving, exercise extreme caution at all times so full attention may be given to vehicle operation. Compatible smartphone required. Text rates and/or data usage may apply. ⁹Driving is serious business and requires your full attention. If you have to use the connected device while driving, exercise extreme caution at all times so full attention may be given to vehicle operation. External device not included. ¹⁰VDC, which should remain on when driving except when freeing the vehicle from mud or snow, cannot prevent accidents due to abrupt steering, carelessness, or dangerous driving techniques. ¹¹TPMS

CHOOSE YOUR TRIM LEVEL

S KING CAB® (4X2)

- 2.5-litre 4-cylinder engine with 152 HP and 171 lb.-ft. of torque
- 5-speed automatic transmission
- Rear access doors
- Forward-facing rear flip-up seats
- 178 mm (7") touch-screen display
- RearView Monitor⁴
- AM/FM audio system with four speakers
- USB port⁹
- Bluetooth® Hands Free Phone System^{2,3}
- Active Brake Limited Slip (ABLS)
- Vehicle Dynamic Control (VDC)¹⁰
- Tire Pressure Monitoring System (TPMS)¹¹

KEY AVAILABLE PACKAGE:
S Value Package



Tire specification may vary.

SV KING CAB (4X2/4X4) CREW CAB (4X4) INCLUDES S EQUIPMENT PLUS:

- 4.0-litre V6 engine with 261 HP and 281 lb.-ft. of torque
- 16" 6-split spoke aluminum-alloy wheels
- Body-colour front bumper
- Dual power heated outside mirrors
- Remote keyless entry
- Vehicle Security System
- Power windows
- Six speakers
- Crew Cab adds:**
 - Four full front-hinged doors
 - 60/40 split rear bench
 - Full-length rear under-seat storage

KEY AVAILABLE PACKAGES:
SV Premium Package (4x4 models only)
SV Premium Package Plus Moonroof (Crew Cab models only)



MIDNIGHT EDITION CREW CAB (4X4) INCLUDES SV CREW CAB EQUIPMENT PLUS:

- Exclusive Midnight Edition black 18" alloy wheels
- Black front grille
- Body-colour front and rear bumpers
- Black door handles and outside mirrors
- Black step rails
- Black Midnight Edition badging



PRO-4X® KING CAB (4X4) CREW CAB (4X4) INCLUDES SV EQUIPMENT PLUS:

- 6-speed manual transmission (King Cab only)
- PRO-4X Bilstein® shocks
- Electronic locking rear differential
- 16" 6-spoke aluminum-alloy wheels
- Skid plates and fog lights
- Utili-track® Channel System
- Factory-applied spray-on bedliner
- SiriusXM® Radio with 3-month complimentary trial access^{3,6}
- Nissan Navigation System with 147 mm (5.8") colour touch-screen display⁷
- NissanConnect® Mobile Apps^{2,3,6}
- Rear Sonar System¹²
- PRO-4X embroidered cloth seat trim
- Crew Cab adds:**
 - Roof rack with crossbars
 - Power sliding glass moonroof with tilt feature
 - Rockford Fosgate®-powered audio system with ten speakers¹
 - Standard Bed (1511 mm/59.5")

KEY AVAILABLE PACKAGE:
PRO-4X Leather Package (Crew Cab models only)



SL CREW CAB (4X4) INCLUDES SV CREW CAB EQUIPMENT PLUS:

- 18" 6-spoke aluminum-alloy wheels
- Roof rack with crossbars and step rails
- Power sliding glass moonroof with tilt feature
- NissanConnect® 147 mm (5.8") touch-screen display^{2,3,6}
- Nissan Navigation System⁷
- NissanConnect® Mobile Apps^{2,3,6}
- Rear Sonar System¹²
- Dual Zone Automatic Temperature Control
- HomeLink® universal garage-door opener
- Rockford Fosgate®-powered audio system with ten speakers¹
- 8-way power adjustable driver's seat
- 4-way power adjustable passenger's seat
- Leather-appointed seats
- Heated front seats
- Leather-wrapped steering wheel

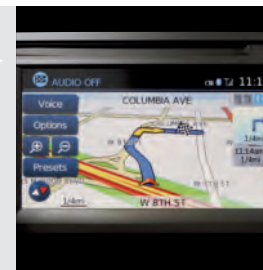

is not a substitute for regular tire pressure checks. ¹²Sonar System may not detect every object. Driver should always check surroundings before driving. See Owner's Manual for safety information. Bluetooth® is a registered trademark of Bluetooth SIG, Inc. Bilstein® is a registered trademark of ThyssenKrupp Bilstein GmbH. Facebook® is a registered trademark of Facebook, Inc. Google® is a registered trademark of Google LLC. HomeLink® is a registered trademark of Genex Corporation. Rockford Fosgate® is a registered trademark of Rockford Corporation. The Sirius, XM, and SiriusXM names and all related marks and logos are trademarks of Sirius XM Radio Inc. TripAdvisor® is a registered trademark of TripAdvisor LLC, Ltd. Twitter® is a registered trademark of Twitter, Inc.

PAINT AND FABRIC



Steel Cloth
S King Cab®



Graphite Cloth
S King Cab



Graphite Cloth
SV King Cab



Steel Cloth
SV Crew Cab



Graphite Steel Cloth
PRO-4X® models



Graphite Leather
PRO-4X Crew Cab



Steel Leather
SL Crew Cab

■ Standard
L Part of PRO-4X® Leather Package

¹Extra cost option

²Crew Cab only

³Available on Midnight Edition

⁴King Cab® only

Nissan has taken care to ensure that the colour swatches presented here are the closest possible representations of actual vehicle colours. Swatches may vary slightly due to the printing process and whether viewed in daylight, fluorescent or incandescent light. Please see the actual colours at your dealer.

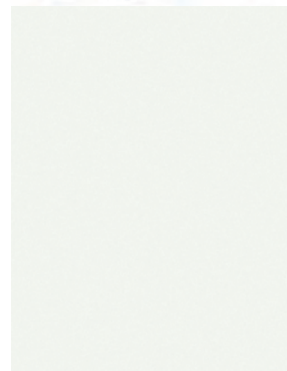

Glacier White QAK



Brilliant Silver¹ K23

	S	SV	PRO-4X	SL
STEEL CLOTH	■	■ ^{2,3}		
STEEL LEATHER				■
GRAPHITE CLOTH		■ ⁴		
GRAPHITE STEEL CLOTH			■	
GRAPHITE LEATHER			L ²	

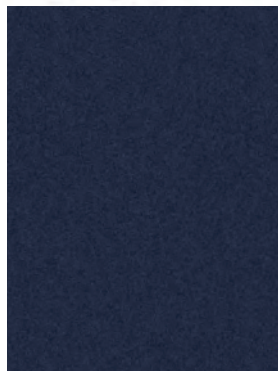

Arctic Blue Metallic¹ RBG



Gun Metallic¹ KAD

	S	SV	PRO-4X	SL
		■ ²		
		■ ⁴		■
			■	
			L ²	

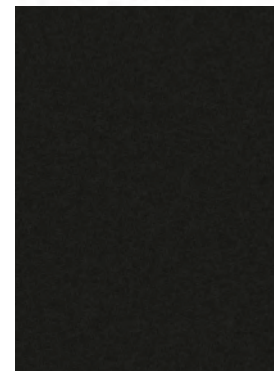

Magnetic Black¹ G41

	S	SV	PRO-4X	SL
		■ ^{2,3}		
		■ ⁴		■
			■	
			L ²	



Cayenne Red¹ NAH

	S	SV	PRO-4X	SL
		■ ²		
		■ ⁴		
			■	
			L ²	

GENUINE NISSAN ACCESSORIES

Every Genuine Nissan Accessory is: custom-fit, custom-designed and durability-tested; available for finance and backed by Nissan's 3 year/60,000 km Accessories limited warranty when installed by dealer at time of your vehicle purchase.⁵

A. Hood Deflector

Helps protect your windshield from bugs and dirt.

B. Fixed Tool Box

Like a treasure box for your tools.

C. Sliding Bed Divider⁶

Keep your gear where you want it.

D. Sliding Bed Extender⁶

Ideal for the long haul.

Additional Accessories:

- All-season Floor Mats
- Fog Lights
- Step Rails
- Tonneau Cover
- Bedliner
- Bed Rail Caps
- Sliding Tool Box
- Fixed Bed Extender
- Tow Hitch Receiver, Class IV⁷
- Weight-distributing Hitch Ball Mount, Class IV⁷
- And More

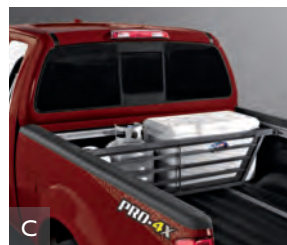

See your Nissan dealer for details, or go to accessories.nissan.ca

BUYING AND OWNING

Finance Options Through Nissan Canada Finance, we offer many attractive lease and loan options that can be tailored to your individual needs. We have unique programs such as the Nissan Grad Program, the Loyalty Program or the Nissan Advantage Program. Please visit our website Nissan.ca/finance to explore all of the options available. We have also made it easy to pre-qualify online. All of our programs come with competitive rates and terms. With our flexible options, driving home a new Nissan has never been easier. Consult your local Nissan Dealership for complete details.

No-Nonsense Warranty Every 2019 Nissan is covered by a 3 year/60,000 km⁸ Comprehensive New Vehicle Warranty, a 5 year/100,000 km⁸ Powertrain Warranty, an 8 year/130,000 km⁸ Emission Control Warranty on selected components, and a 5 year/unlimited km Corrosion Perforation Warranty. As a Nissan owner, you'll also receive a 3 year Roadside Assistance program available to you 24 hours a day. Terms, conditions and exclusions apply. See Warranty Information Booklet for complete details.

Added Security Plan (ASP) For ultimate peace of mind, consider the Nissan Added Security Plan. It's our commitment to be there for you, and to help you leave your worries behind. Different plans, available for both purchased and leased vehicles, let you tailor the coverage to your driving habits.

Security+Plus™ Prepaid Maintenance Plan The smart choice when it comes to maintaining your new Nissan. Honoured at all participating Nissan Dealers in Canada and the U.S., your vehicle is cared for by factory-trained technicians using Genuine Nissan Parts. And best of all, there's no worrying about price increases on parts or service in the future. A variety of plans are available. Ask your Dealer for details.



⁵See your Nissan Dealership and read the actual limited warranty. ⁶Cargo and load capacity limited by weight and distribution. Always secure all cargo. Heavy loading of the vehicle with cargo, especially on the roof, will affect the handling and stability of the vehicle. ⁷See Nissan Towing Guide and Owner's Manual for additional information. ⁸Whichever occurs first.

